

NOTE:

1. Material:

Housing: Thermoplastics,UL94V-0(LCP,BLACK,Halogen free)  
 Contact: Copper Alloy  
 Shell: Stainless Steel

2. FINISH:

Contact: Gold 3u" Plated on Contact Area,  
 Gold Flash Gold Plated on Nickel Over All.  
 50u" Min.Nickel Underplating Over All.

Shell: 50u" Min.Nickel Underplating Over All.

3. Specification:

3.1: Electrical:

Insulation Resistance(EIA-364-21):

100MΩ Min. at 100V/DC

Contact Resistance(EIA-364-06): 30 mΩ Max.

Dielectric Withstanding Voltage(EIA-364-20):

No discharge, flashover or breakdown at 100V/AC 1Minute

4. Micro USB TID Number:60001810

5. Ordering Information

MUB-BF-SMT-041-HB

Micro USB SERIES  
 CONNECTOR TYPE B TYPE FEMALE  
 CONNECTOR STYLE SMT TYPE  
 HALOGEN FREE, BLACK  
 FOLLOW NUMBER

Pin Assignment

Contact Number	Signal Name	Typical Wiring Assignment
PIN 1	VBUS	Red
PIN 2	D-	White
PIN 3	D+	Green
PIN 4	ID	<Ra_PLUG_ID
PIN 5	GND	Black
SHELL	Shield	Drain Wire

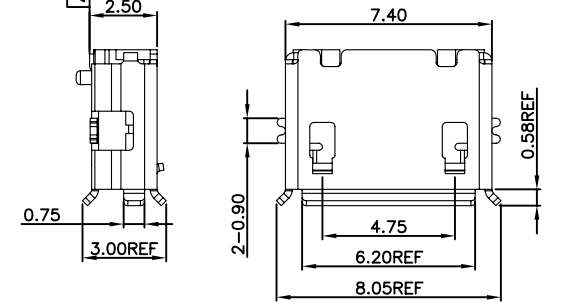
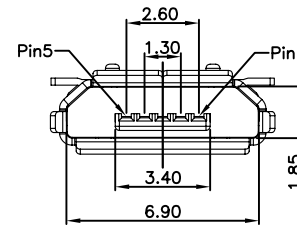
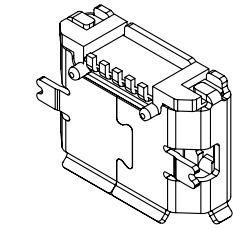
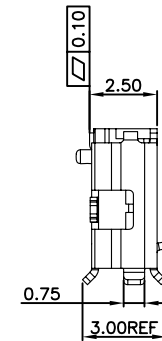
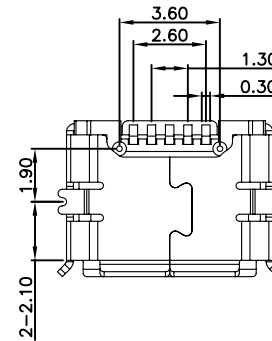
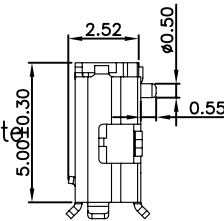

RECOMMENDED PCB LAYOUT(TOP VIEW)  
 GENERAL TOLERANCES:±0.05

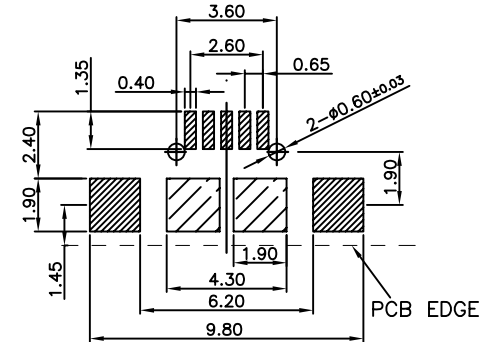

RoHS Compliant

單位 UNIT	MM	*: Inspection Item	SHINE HEH TECHNOLOGY CO., LTD.	
比例 SCALE	1:1	◎ Cp/Cpk and SPC Control Item	星赫科技有限公司	
張數 SHEET	1*1	TOLERANCE UNLESS OTHERWISE SPECIFIED	圖號 DWG NO.	MUB-BF-SMT-041-HB
製圖 DRAWN	.X±0.25	X'±3'	名稱 TITLE	Micro USB SMT 5Pin(B型) 不銹鋼黑
版本 REV.	.XX±0.20	X'±1'	角法 PROJ.	殼芯有定位柱,全金3u"
設變內容 MODIFICATION	.XXX±0.10	.XX±	客户图	

日期 DATE	08.01.20	王磊	谭达兴
修改 DRAW			
核准 APPROVE			
審核 CHECKED			