

RoHS Compliant

NOTE:

1. Material:

Body(Housing): Thermoplastics,UL94V-0(Color: Black,Halogen Free).
 Upper or lower Molding Housing: Thermoplastics,UL94V-0(Color: Black,Halogen Free).
 Back Cover: Thermoplastics,UL94V-0(Color: Black,Halogen Free).
 Contact: Copper Alloy
 Shell: Copper Alloy
 Mid Shield Plate:Stainless Stell.
 EMC PAD: Stainless Stell.

2. FINISH:

Contact: Au 15u" Plated on Contact Area,
 80u" Min. Bright Tin Plated on Solder Area
 30u" Min.Nickel Underplating Over All.
 Shell: 50u" Min. Solderability Nickel plated Over All.
 Mid Shield Plate: 50u" Min. Solderability Nickel plated over All

3. Specification:

3.1: Electrical:

Current Rating: 5A For Pin(A4,A9,B4,B9), 1.25A For Others Pin
 Insulation Resistance(EIA-364-21):
 100MΩ Min. at 500V/DC for 1Minute.
 Contact Resistance(EIA-364-06): 50 mΩ Max.
 Dielectric Withstanding Voltage(EIA-364-20):
 No discharge, flashover or breakdown at 100V/AC 1Minute

3.2: Mechanical Characteristic:

Insertion Force: 5~20N
 Extraction Force: 8~20N.
 Durability :10000 Cycles

4. Recommended process IR REFLOW:260°C, 3-5seconds.

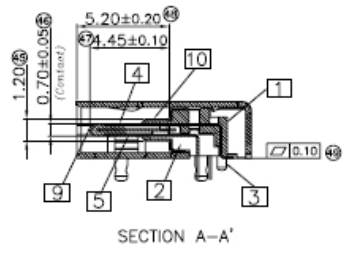
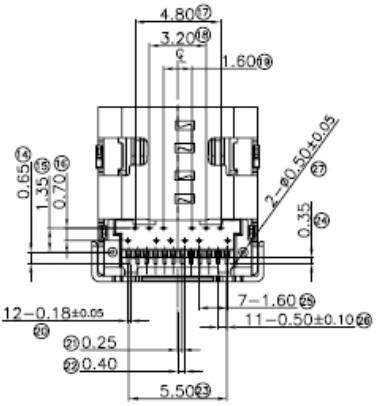
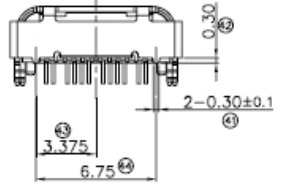
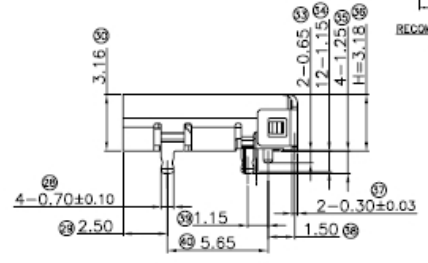
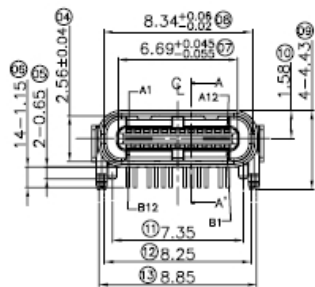
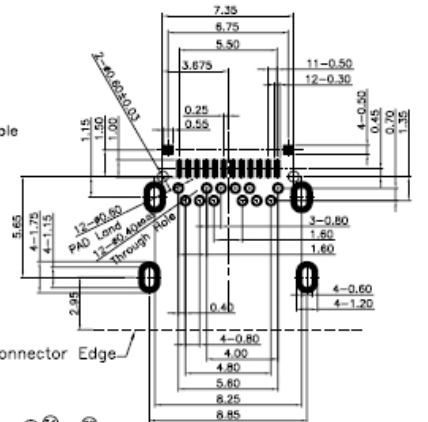
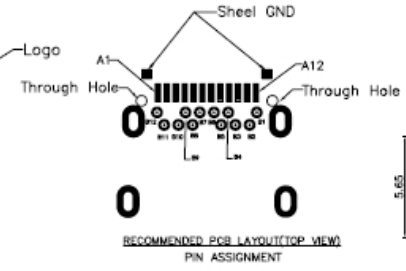
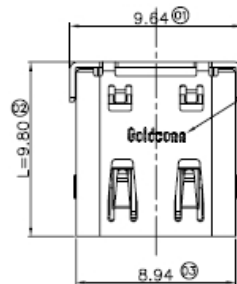

CONTACT PIN NUMBER	SIGNAL NAME
A1,A12,B1,B12	GND
A4,B4,A9,B9	VBUS
A2	SSTx1
A3	SSTx1
A5	CC1
A6	Dp1
A7	Dn1
A8	SBU1
A10	SSRx2
A11	SSRx2
B2	SSTx2
B3	SSTx2
B5	CC2
B8	SBU2
B10	SSRx1
B11	SSRx1

Ordering Information
 USB CF SMD -004-HB
 USB SERIES | Halogen Free,Black
 CONNECTOR TYPE | FOLLOW NUMBER
 C TYPE FEMALE(Receptacle) | CONNECTOR STYLE SMT+DIP TYPE

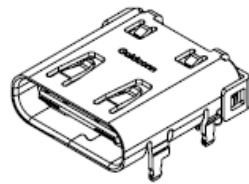

Item NO.	品名 NAME	料号 P/N	表面处理 PLATING	备注 MARK
8	EMC PAD	GUB61U-***-VX00	Stainless Steel , Clear,No Plated	2PCS
7	Mid Shield Plate	GUB62U-***-VN12	Stainless Steel , Solderability Ni Plated	1PCS
6	Shell	GUB60B-***-NN12	Copper Alloy , Solderability Ni Plated	1PCS
5	Lower Terminal	GUB63D-***-VP15	Copper Alloy , Au15u" Plated on contact Area	12PCS
4	UP Terminal	GUB63D-***-VP15	80u" Min. Bright Tin Plated on Solder Area	12PCS
3	Molding BODY	HUT45L-***-BM0N-H	LCP Black(Halogen Free)	1PCS
2	Molding Lower Housing	HUT46L-***-BM15-H	LCP Black(Halogen Free)	1PCS
1	Molding Upper Housing	HUT47L-***-BM15-H	LCP Black(Halogen Free)	1PCS

單位 UNIT	MM	* Inspection Item	星赫科技有限公司 SHINE TECH TECHNOLOGY CO., LTD.
比例 SCALE	1:1	■ Cp/Cpk and SPC Control Item	
張數 SHEET	1*1	TOLERANCE UNLESS OTHERWISE SPECIFIED	圖號 DWG NO.
製圖 DRAWN	Lzb	.X±0.25 .X'±3' .XX±0.20 .X'±1' .XXX±0.10 .XX'±1'	名稱 TITLE
版本 REV.	NEW ISSUE	日期 DATE	15.08.12
修改 MODIFICATION		修改 DRAW	
核准 APPROVE		審核 CHECKED	
			角法 PROJ
			客户图