

SECTION:A-A

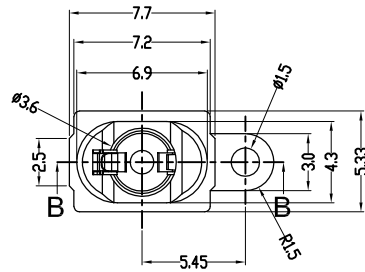

符合環保要求
環保標註: RoHS Halogen

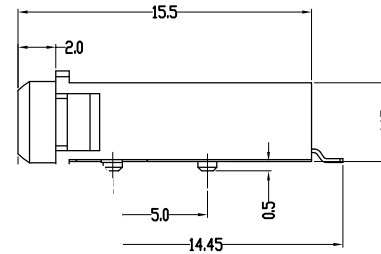
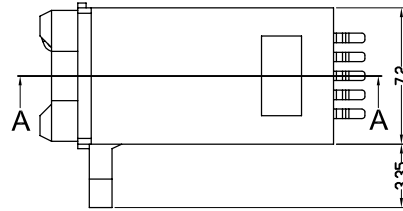
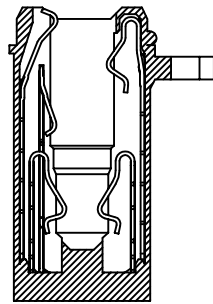
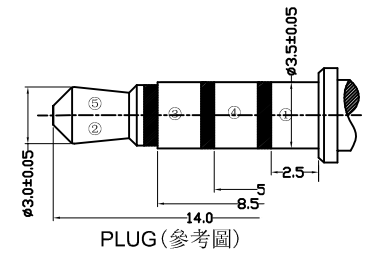
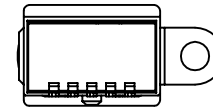

SECTION:B-B

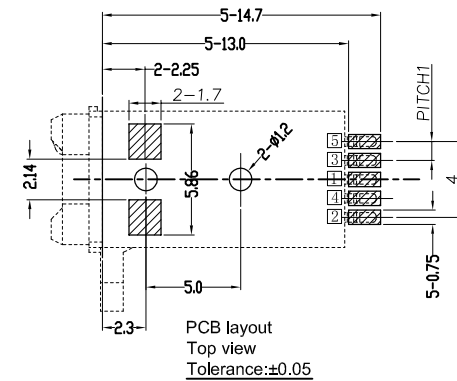
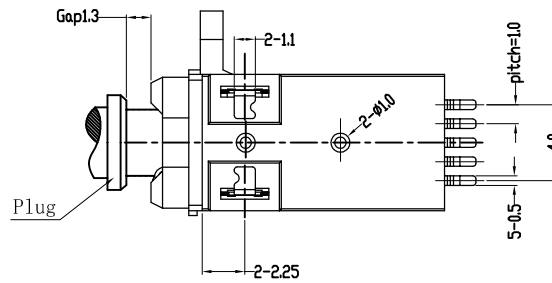

SCHEMATIC

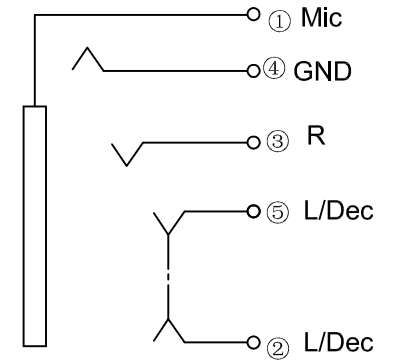

⑥	TERMINAL	1	PHOSPHOR BRONZE t=0.15mm
①~⑤	TERMINAL	1	PHOSPHOR BRONZE t=0.2mm
C	RUBBER RING	1	SILICA GEL WHITE
B	COVER	1	HIGH TEMPERATURE PLASTIC
A	HOUSING	1	HIGH TEMPERATURE PLASTIC
SING	DESCRIPTION	QT'Y	PLATING

3u"Au on Contact Area And Gold Flash On Other Area.



DRAWN BY: **J.W-Liang** REVIEWED BY: **X.H.Liu** CHECKED BY: **Sunny** APPROVED BY: **Joe**

TOLERANCE CHART:	
x.	±0.3mm
x.x	±0.2mm
x.xx	±0.1mm
x.xxx	±0.05mm

VIEW:		UNIT:	mm	SCALE:	1 : 1
PART NAME:	AUDIO-JACK	DATE:	2014/11/21	REV:	A
MODEL NO.:	WP-36460-GP	DRAWING NO.:			